

# SPHEROSYN SCALE SPRING SUPPORT

## Installation Guide

# NEWALL

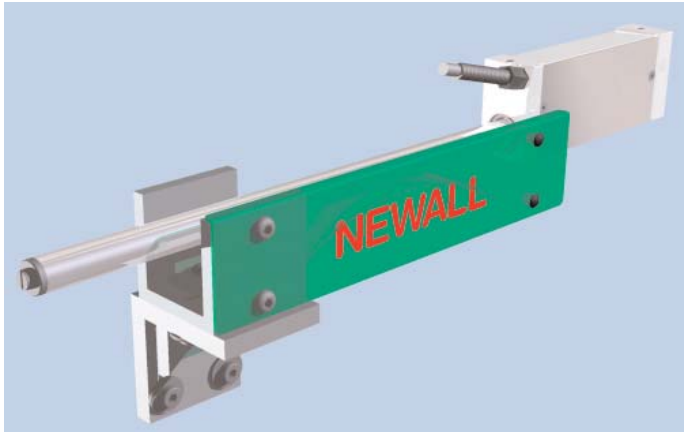

SPRING SUPPORT KIT Part No.  
600-84600

View shows one set of parts assembled supporting the scale.

### SPACING OF SUPPORTS

Supports should be positioned along the length of scale spaced in increments of 1.5m max  
Between 2.5 & 3.0m scale lengths use 1 off support.  
Between 3.0 & 4.5m scale lengths use 2 off supports.  
For longer lengths use an additional support for every 1.5m added.

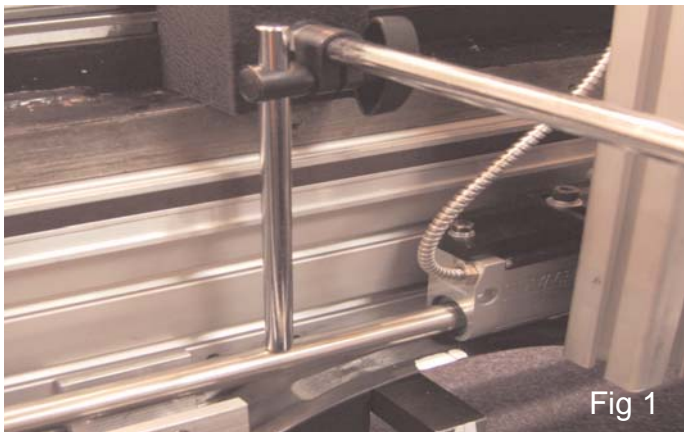

### INSTALLATION SEQUENCE

A suitable fixture/ depth gauge is required for measurement purposes during the setting up sequence.

The reader head should be installed and aligned in both planes of movement as described in the general installation guide.

Supports are installed in their allocated spaced out positions and adjusted by eye into their vertical position so as to support the scale during the setting up procedure. Install the scale tube.

The head is traversed to the first support position. The support may need to be loosened as necessary so that it is not supporting the scale. During this operation the head should be supporting the scale whilst measurements are taken. Refer to Fig.1.

Measure and gauge the top surface of the scale. Keep the gauge set at this reading. With the gauge remaining in this support position traverse the head to the next support position.

The scale will now be resting lower than the gauge position. Raise the support so that the scale touches the gauge. Refer to Fig.2.

Move the gauge to the next support position. The head has previously been moved to this position.

Repeat the measurement and support adjustment for the remaining supports as per the previous operations.

Fig.3. shows support in final adjusted state.

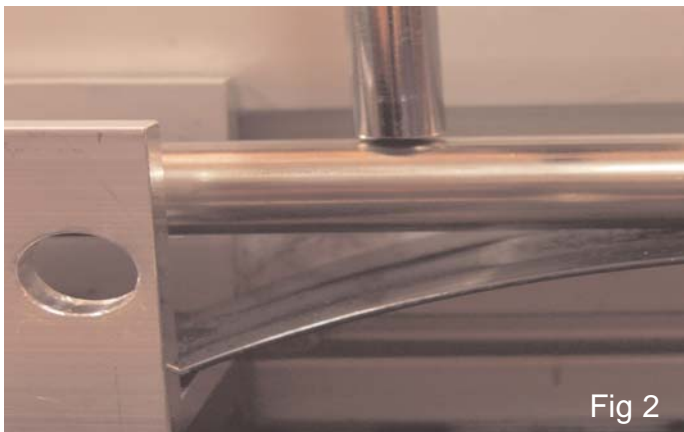

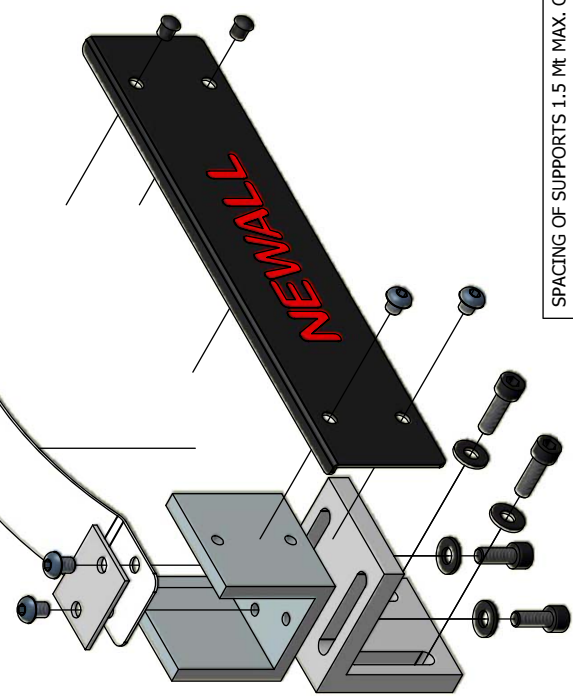
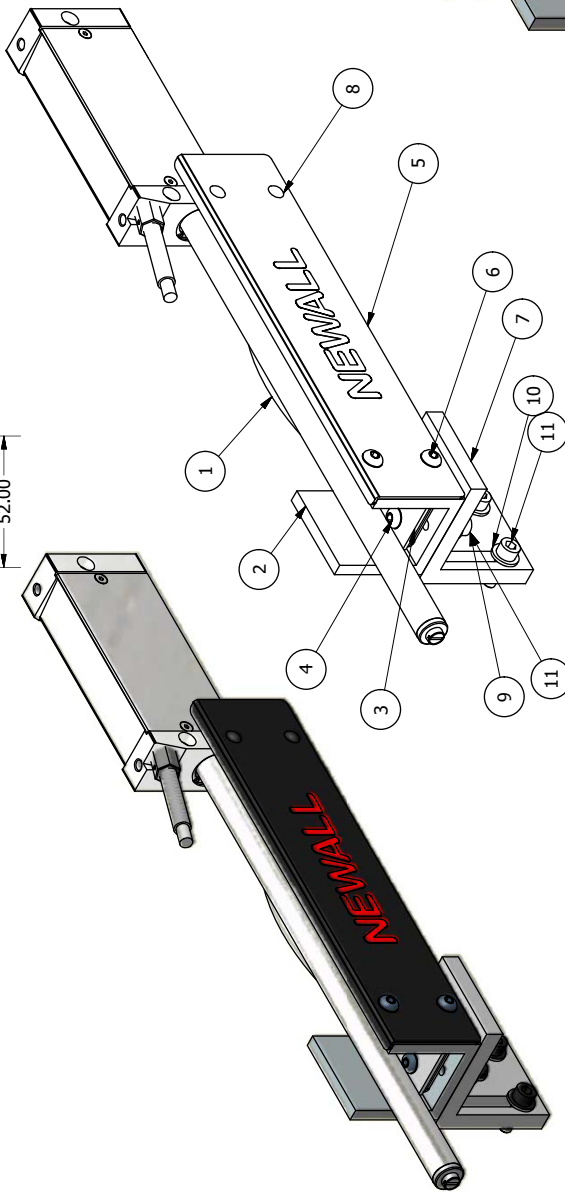
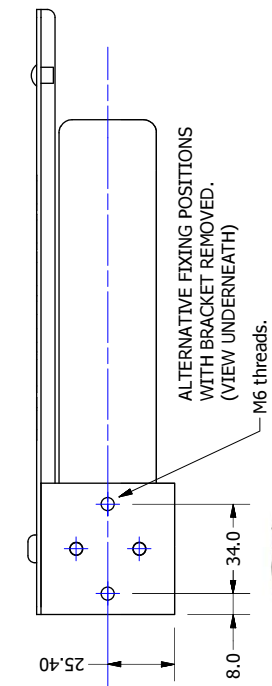
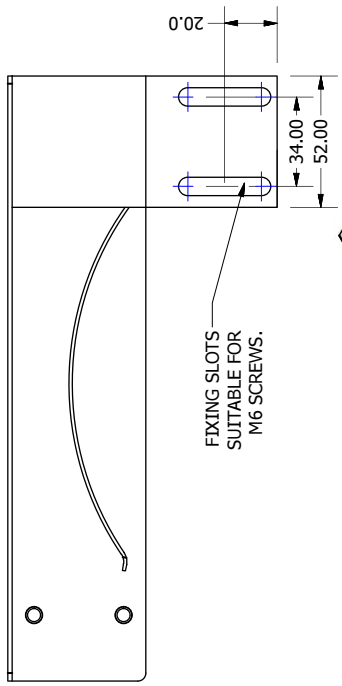
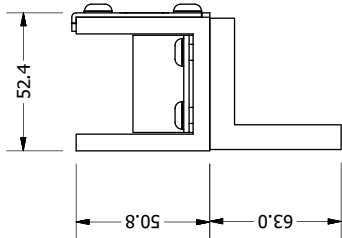
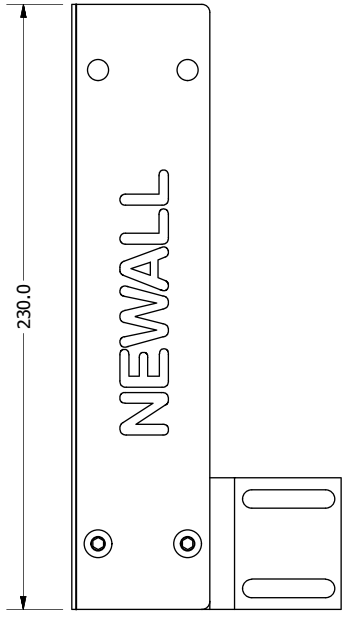

Parts List

ITEM	QTY	PART NUMBER	DESCRIPTION
1	1	294-95840	LEAF SPRING
2	1	294-95910	BRACKET
3	1	294-95930	CLAMP PLATE
4	2	086-14255	M6x8 SOCKET BUTTON SCREW
5	1	294-95920	PLATE
6	2	086-14256	M6x6 SOCKET BUTTON SCREW
7	1	294-22520	BRACKET
8	2	294-95940	DOME PLUG
9	2	086-14380	M6x16 SOCKET CAP HEAD SCREW
10	2	018-12-030	M6x20 SOCKET CAP HEAD SCREW
11	4	104-10260	M6 FLAT WASHER

SPACING OF SUPPORTS 1.5 ML MAX. CENTRES ALONG SCALE LENGTH.

TITLE		SPHEROSYN SCALE SPRING SUPPORT		MATERIAL/FINISH		SCALE UNLESS OTHERWISE STATED: 0.5=1		TOLERANCES: 0 DECIMAL PLACES ±0.2 1 DECIMAL PLACES ±0.1 2 DECIMAL PLACES ±0.1	
DRAWN   John.d		NEWALL		England		SHEET DRAWING 1 OF 1		REVISION NUMBER 316-85610	
DATE   23/02/2009		Leicester						ISS.	
REV. ISS.		ALTERATION							

**SPHEROSYN SCALE SPRING SUPPORT KIT**  
**Part No. 600-84600**